

Standard features:

- sturdy nylon latches (2)
- metal core hinges (2)

Technical specifications:

- Material:** polypropylene
- Unit weight:** 2.06 lb (0.94 kg)
- Qty per pack:** 10 units
- Pack weight:** 25 lbs (11.34 kg)
- Pack volume:** 4.74 cu. ft (0.135 m³)
- Colors available:** 001-Black
002-White
035-Blue
038-Red
050-Mercury
058-Graphite
065-Navy

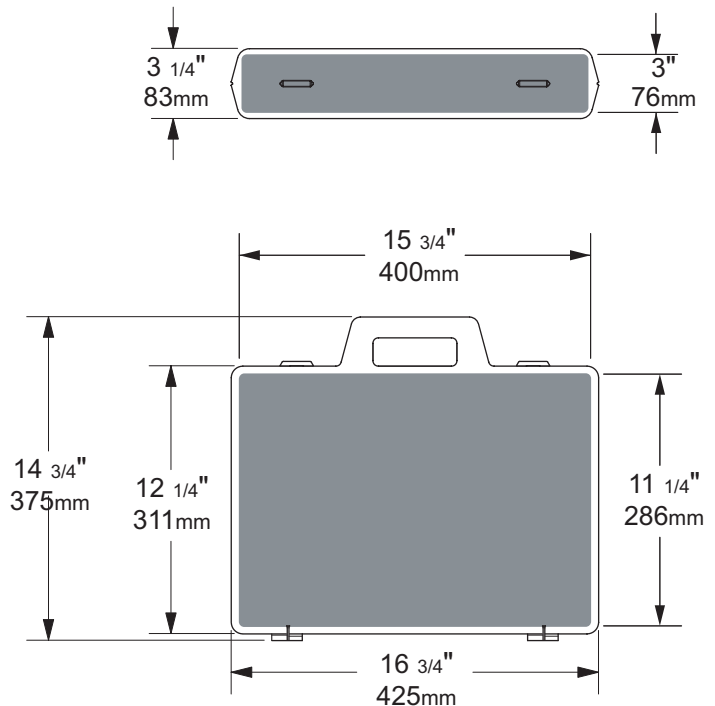
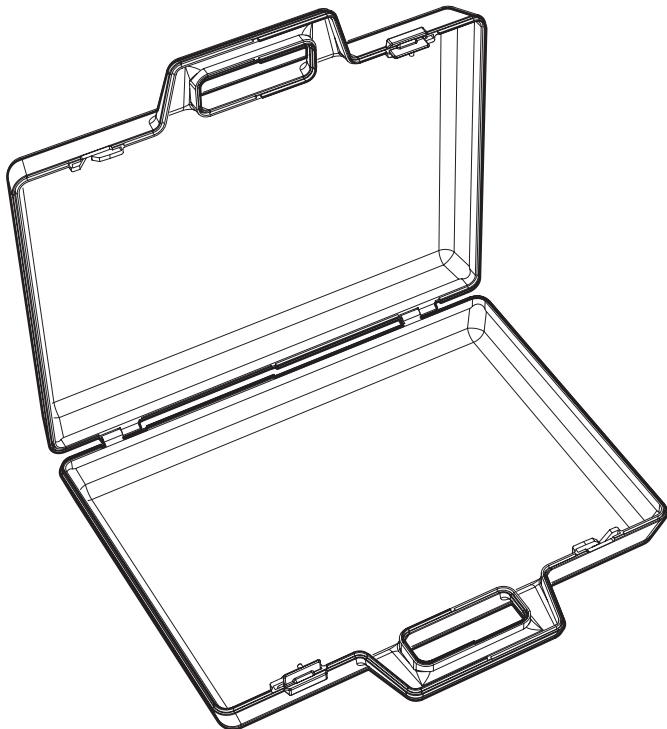
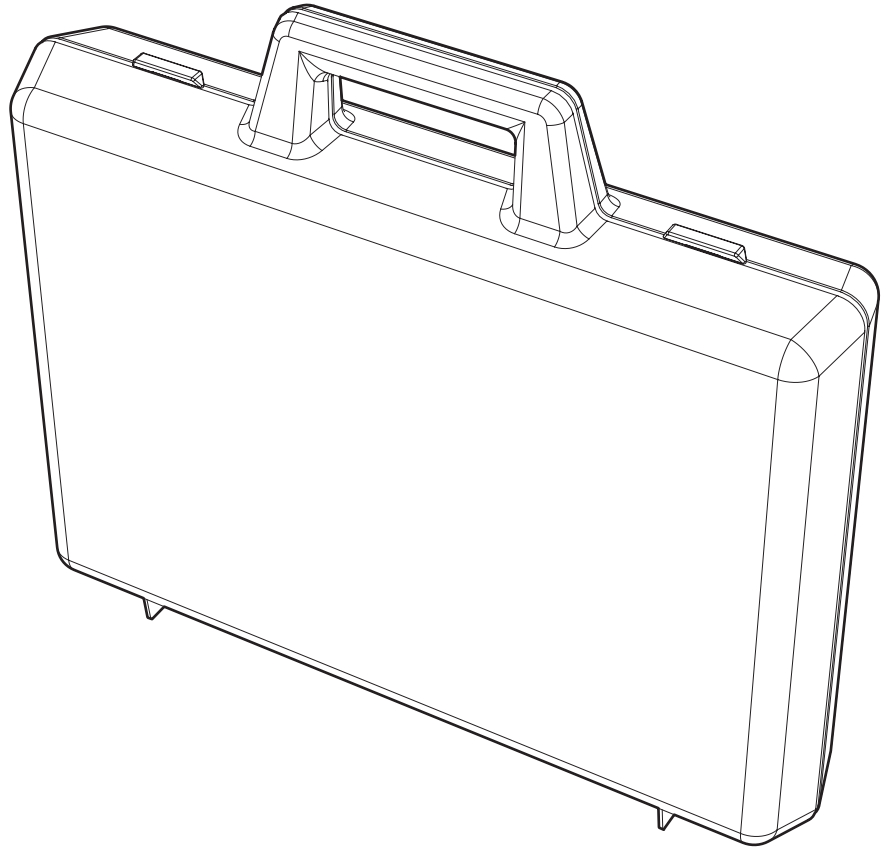

interior net usable space =