

Standard features:

- sturdy nylon latches (2)
- metal core hinges (2)

Technical specifications:

- Material:** polypropylene
- Unit weight:** 1.0 lb (0.45 kg)
- Qty per pack:** 10 units
- Pack weight:** 13 lbs (5.9 kg)
- Pack volume:** 2.42 cu. ft (0.068 m³)
- Colors available:** 001-Black
002-White
035-Blue
038-Red
050-Mercury
058-Graphite
065-Navy

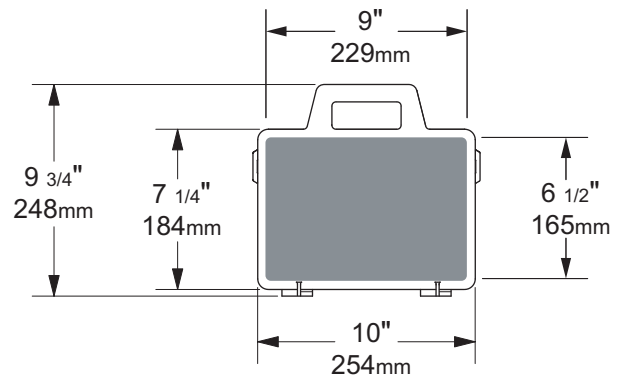
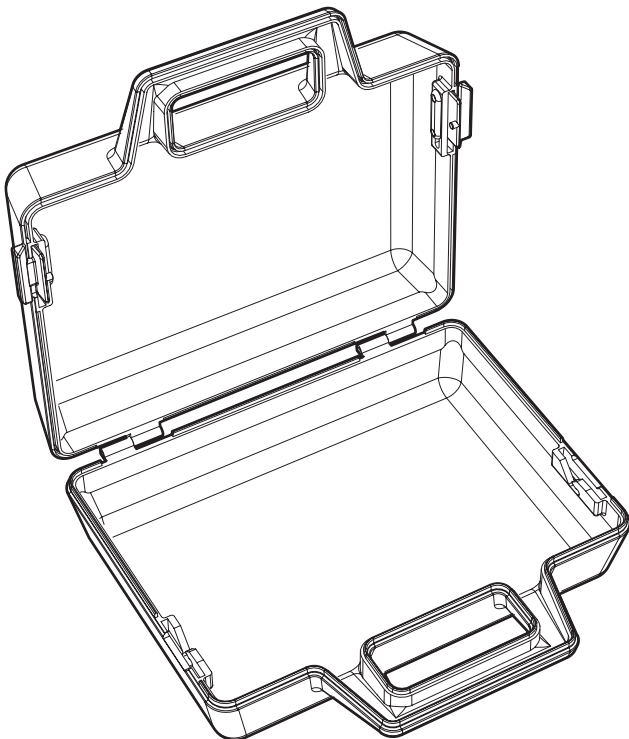
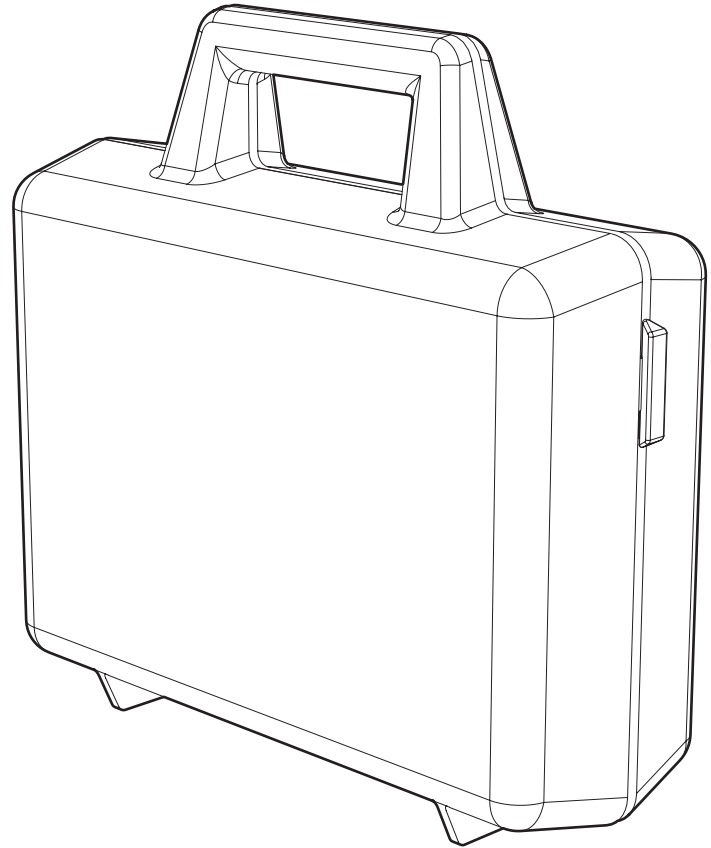

interior net usable space =